















28 504 979



- 180-210mm projection
- ball-joint pivotable through 30°
- PURIFY RAIN, max. flow rate 7 l/min (at 3 bar)
- with anti-scale system
- spray head Ø 100mm
- rosette Ø 55 mm
- 1/2" connection
- This product can help a building meet the requirements of Green Building Rating Systems, e.g. LEED®, BREEAM®, DGNB

Fits: TARA, LISSÉ, VAIA, META

	Chrome	28 504 979-00 0050
	Brushed Platinum	28 504 979-06 0050
	Platinum	28 504 979-08 0050
	Dark Chrome	28 504 979-19 0050
	Light Gold	28 504 979-26 0050
	Light Gold	28 504 979-26
	Brushed Light Gold	28 504 979-27 0050
	Brushed Light Gold	28 504 979-27
	Brushed Durabronze (23kt Gold)	28 504 979-28 0050
	Matte Black	28 504 979-33 0050
	Brushed Bronze	28 504 979-42 0050
	Brushed Champagne (22kt Gold)	28 504 979-46 0050
	Champagne (22kt Gold)	28 504 979-47 0050
	Brushed Chrome	28 504 979-93 0050
	Brushed Dark Platinum	28 504 979-99 0050

Recommended miscellaneous



- Concealed wall elbow -** 35 085 970 90
- max. recess depth 163 mm
 - min. recess depth 90 mm

28 504 979

mm [inches]

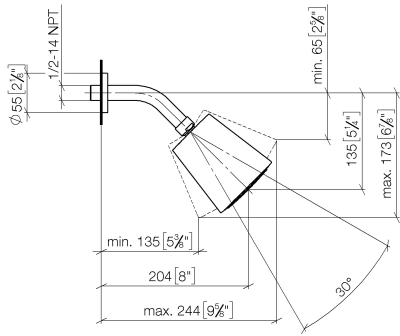

Flow rate chart

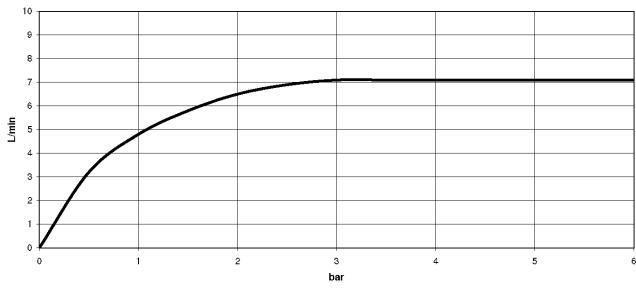

28 504 979

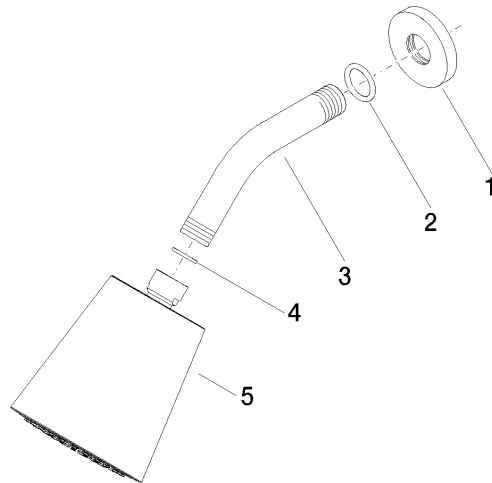

Spare parts list

No.	Item Number	Name	Quantity used	Delivery time
1	09 27 22 003-00	rosette	1	10
2	90 14 10 026 00 90	seal	1	2
3	09 11 03 011-00	connection	1	10
4	90 14 20 002 00 90	seal	1	2
5	90 12 05 054 00-00	shower	1	10